

Metal Storage Furniture > Price Book > USA > September 2022



OFFICE
FURNITURE
SOLUTIONS

TABLE OF CONTENTS

AVAILABLE SPECIALS	2
QUICKSHIP PROGRAM	2
SPECIFICATIONS	3
CHOOSING THE RIGHT STORAGE FURNITURE	3
CAPACITY AND FILING SPACE	4
COUNTERWEIGHTS AND ANCHORS	5
LOCKING PROGRAM	5
LATERAL FILES / CABINETS AND BOOKCASES	6
WARDROBES / MULTIFUNCTION STORAGE FURNITURE	7
VERTICAL FILES / COMBINED TOWERS / PEDESTALS	8
OPTION SPECIFICATIONS AND FINISHES	9

METAL STORAGE FURNITURE

LATERAL FILES	10
CABINETS	10-11
BOOKCASES	11
WARDROBES	11
MULTIFUNCTION STORAGE FURNITURE	11-12
VERTICAL FILES	12-13
LAMINATE TOPS	13
PEDESTALS	13-14
COMBINED TOWERS	14-15
ACCESSORIES	15-16

FIND OUT ABOUT OUR AVAILABLE SPECIALS!

Other special products are also available upon request: lockers, plan files, display cases, filing bookcases, etc. For information purposes, here are some examples of special products:

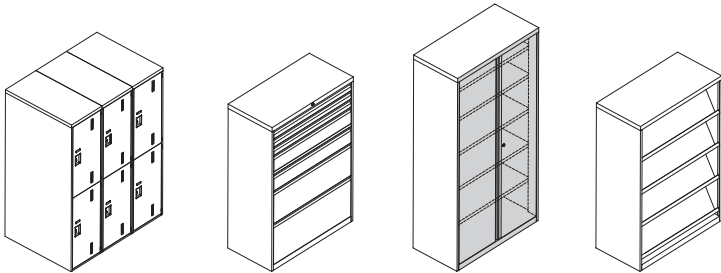

Customized locker

Multidrawer lateral file

2-tone cabinet
72" H (1829 mm)

Display case

CUSTOMIZED COLORS:

- It is possible to get a two-tone layout by specifying the front and case colors.
- It is also possible to develop a storage unit with your choice of color.

CUSTOMIZED DRAWERS DIMENSIONS AND CONFIGURATIONS:

- Standard-sized cases can easily accommodate your choice of drawer heights: 3" (76 mm), 6" (152 mm), 9" (229 mm), 12" (305 mm), 13 1/2" (343 mm) and 15" (381 mm).
- A storage unit can also be made with special dimensions (W x H x D).

IMPORTANT:

No minimum quantity necessary. However, certain conditions, dimensional limitations and development costs may apply. For any special request, please send your request to special@groupelacasse.com or contact Customer Service for further information.

LACASSE QUICKSHIP PROGRAM*

Products and suggested layouts identified by this pictogram are part of the Lacasse quick delivery program.

* Due to current market conditions, always refer to our Lead-Time Guide for a confirmation of our current Lacasse QuickShip lead-times.



PROGRAM CONDITIONS AND LIMITATIONS:

- Maximum of five (5) of each item and each color per order.
- QuickShip products are ready for shipment after reception of a ready-to-process order and delivered on next available trailer.

IMPORTANT:

Place QuickShip orders separately from regular Lacasse orders. When preparing QuickShip orders, indicate the code "QS" in front of the QuickShip product code; i.e.: QSRIDFS-183628LF2.

SPECIFICATIONS

CHOOSING THE RIGHT STORAGE FURNITURE

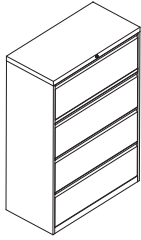

Lateral file with fixed fronts

Offers a superior filing capacity. Perfect for any workstation; allowing an easy access to files.

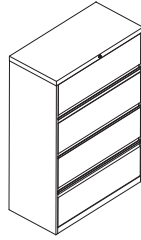

Lateral file with receding fronts and roll-out shelves

Designed for a quick consultation of documents with end-tabs. Perfect for the medical field.

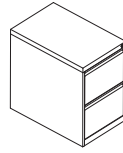

Pedestal / vertical file

Designed to be integrated into all your projects and requires little floor space. Vertical file is ideal for long-term filing.

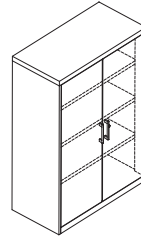

Cabinet / bookcase

Adjustable shelves allow an optimal use of storage space. Perfect for binders, books, catalogues and stationery.

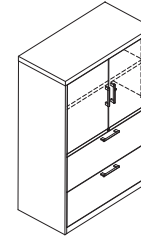

Multifunction storage unit / combined towers

The different compartments offer diversified storage space. Perfect for a small volume of filing and for an individual workstation.

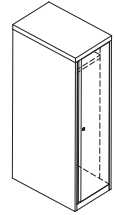

Wardrobe

Offers a safe personal storage space for clothes, shoes, bags, etc.

General Information

- In this price book, dimensions are exact and may differ from other Groupe Lacasse collections.
- Metal storage furniture is GREENGUARD GOLD certified and meets or exceeds ANSI/BIFMA standards. See product specifications for more details.
- Products are made from 68% recycled materials and are 99.5% recyclable.
- Furniture on glides is shipped assembled and ready to use.
- Cleaning method: clean furniture with a damp cloth and mild soap. Dry the surface with a soft cloth.

Design

- All products in this collection were carefully designed with horizontal lines that maintain a uniform appearance among the different storage units.
- Inset drawers and doors create a sleek and neutral look.

- The case construction with smooth seams and no overlaps allows to place the storage units side by side without creating unwanted gaps.
- The storage furniture gets its impeccable look from a smooth-finish powder paint.

General Specifications

- Each unit is equipped with 4 levelers that are accessible from the inside and allow an adjustment of 1" (25 mm), ensuring stability on uneven floors.
- The inside of storage units and drawers are the same color as the outside.
- Storage units with a height of 27 7/8" (708 mm) can support a work surface with a conventional height of 29" (737 mm) or more.
- Adding a laminate top on a unit that has a height of 27 7/8" (708 mm) or 40 1/16" (1018 mm) creates a work space at sitting or standing heights. See page 13.
- Classic (Z) and Straight (K) pulls are interchangeable; 5" (128 mm) on center drillings.

Steel Gauges







Storage furniture is entirely made and welded with first-quality cold-rolled steel. Please note that the lower the gauge, the thicker the steel.

	Lateral files / Multifunction files / Low storage units	Vertical files / Pedestal	Cabinets / Wardrobes	Bookcases	Cabinets-Lateral files combos	Combined towers
Top	20	20	20	20	20	20
Side	20	20	20	20	20	20
Back	20	20 / 14	20	20	20	20
Bottom	20	16	16	16	20	16
Drawer front	20	20	-	-	20	20
Drawer side	18	20	-	-	18	20
Drawer bottom	20	20	-	-	20	20
Top reinforcement	18	18	-	-	18	-
Side reinforcement	18	18	-	-	18	-
Crossbar	20*	20* / -	-	-	20	-
Leveler support	16	-	-	-	16	-
Flip system	20*	-	-	-	-	-
Door	-	-	20	-	20	20*
Shelf	-	-	20	20	20	20
Shelf support	-	-	18 / -	18	18	18

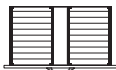
* If applicable.

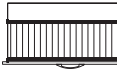
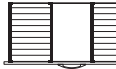
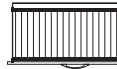
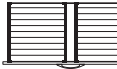
SPECIFICATIONS

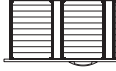
LATERAL FILES CAPACITY AND FILING SPACE

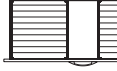
Fixed front				Filing Space - Letter Size		Espace de classement - Format légal	
Tiroirs	W x D x H (in)	W x D x H (mm)	Capacity	Left / Right	Front / Rear*	Left / Right	Front / Rear*
30" W (762 mm)	26 3/4 x 15 1/16 x 11 5/8	679 x 383 x 295	90 lb / 40,8 kg	 26 3/4" (679 mm)	 30 1/8" (765 mm)	 26 3/4" (679 mm)	 15 1/16" (383 mm)
36" W (914 mm)	32 3/4 x 15 1/16 x 11 5/8	832 x 383 x 295	105 lb / 47,6 kg	 32 3/4" (832 mm)	 30 1/8" (765 mm)	 32 3/4" (832 mm)	 30 1/8" (765 mm)
42" W (1067 mm)	38 3/4 x 15 1/16 x 11 5/8	984 x 383 x 295	125 lb / 56,7 kg	 38 3/4" (984 mm)	 45 3/16" (1148 mm)	 38 3/4" (984 mm)	 30 1/8" (765 mm)

* Requires front-to-back hanging bars, sold separately. See page 16.

Note: Fixed and roll-out shelves with retractable door have an interior height of 10 5/8" (270 mm) instead of 11 5/8" (295 mm).

CABINETS AND BOOKCASES CAPACITY AND FILING SPACE

Storage unit	Shelves Dimensions				Capacity (weight uniformly distributed)	
	Cabinet		Bookcase		Cabinet	Bookcase
	W x D x H (in)	W x D x H (mm)	W x D x H (in)	W x D x H (mm)		
30" W (762 mm)	29 3/4 x 14 1/4 x 3/4	756 x 362 x 19	29 3/4 x 16 3/4 x 3/4	756 x 425 x 19	90 lb / 40,8 kg	105 lb / 47,6 kg
36" W (914 mm)	35 3/4 x 14 1/4 x 3/4	908 x 362 x 19	35 3/4 x 16 3/4 x 3/4	908 x 425 x 19	105 lb / 47,6 kg	125 lb / 56,7 kg
42" W (1067 mm)	41 3/4 x 14 1/4 x 3/4	1060 x 362 x 19	41 3/4 x 16 3/4 x 3/4	1060 x 425 x 19	125 lb / 56,7 kg	145 lb / 65,8 kg

STORAGE SPACE AND CAPACITY OF VERTICAL FILES, TOWERS AND PEDESTALS

Storage unit	Interior Dimensions*				Capacity (weight uniformly distributed)	
	Box drawer		File drawer		Box drawer	File drawer
	W x D x H (in)	W x D x H (mm)	W x D x H (in)	W x D x H (mm)		
18" D (457 mm)	12 x 16 x 5 3/8	305 x 406 x 137	12 x 16 x 11 5/8	305 x 406 x 295	17 lb / 7,7 kg	36 lb / 16,3 kg
22" D (457 mm)	12 x 16 x 5 3/8	305 x 406 x 137	12 x 16 x 11 5/8	305 x 406 x 295	17 lb / 7,7 kg	36 lb / 16,3 kg
24" D (610 mm)	12 x 16 x 5 3/8	305 x 406 x 137	12 x 16 x 11 5/8	305 x 406 x 295	17 lb / 7,7 kg	36 lb / 16,3 kg
28" D Letter (711 mm)	12 x 24 x 5 3/8	305 x 610 x 137	12 x 24 x 11 5/8	305 x 610 x 295	26 lb / 11,8 kg	54 lb / 24,5 kg
28" D Legal (711 mm)	15 x 24 x 5 3/8	381 x 610 x 137	15 x 24 x 11 5/8	381 x 610 x 295	32 lb / 14,5 kg	67 lb / 30,4 kg

* Mobile pedestals: remove in height 1" (25 mm) per file drawer and 1/2" (13 mm) per box drawer.

COUNTERWEIGHTS AND ANCHORS

In order to meet ANSI/BIFMA standards of stability, some products must be installed under a work surface, be ganged/anchored or have a counterweight. Please see each product's Specifications section for more details.

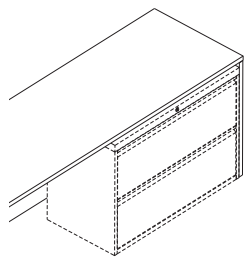

Installation under a work surface

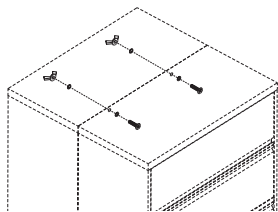

Back-to-back or side-by-side ganging*

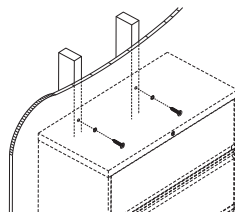

Wall anchoring

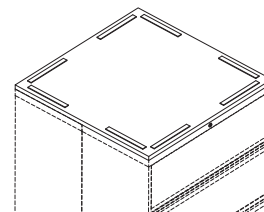

Ganging with a laminate top

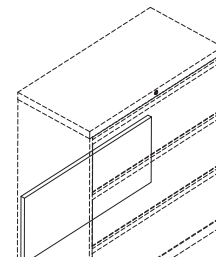

Factory-installed or optional counterweight**

* Ganging kit **RINNN-GKIT** sold separately, page 16.

** Refer to the price book for more details (see pages 15-16).

LOCKING PROGRAM

Standard Lock

- All storage units except bookcases are equipped with a single lock system. Cabinets/Lateral files combos have 2 locks.
- Each key lock has a factory-installed lock plug and key numbers are attributed in random fashion for each storage unit.
- It is possible to change lock plugs and install a keyed alike system. Master Key and Control Key also offered. For further information, contact the Groupe Lacasse Customer Service.
- The locking system accepts a key lock (standard) or an electronic lock (option).

Electronic Lock (option)

- The Versa Mini, from Numeris by Digilock, is an electronic lock intended to secure storage furniture for hospitality, retail and healthcare professionals.
- When specified in option, the electronic lock (D) is factory installed. A key lock on an existing unit can be changed for an electronic lock (see page 16).
- Installed horizontally with keypad on the left on a file and vertically installed with keypad at top on a cabinet or a wardrobe.

- The lock uses 2 small coin cell lithium batteries for an average of 50,000 actuations. The battery compartment is located within the front of the lock to allow changing batteries without unlocking or opening the door.
- The keypad interface allows the user to operate the lock with a 4 to 7-digit user code for a multitude of combinations.
- Manager Keys (required and sold separately, see page 16) provide bypass access in case the user is unable to access their storage unit. It can also operate the locks in case of battery failure. Manager Keys are programmed into the lock system by a unique Programming Key (required and sold separately, see page 16).
- The lock is programmed to assigned use functionality by default, which allows up to 20 simultaneous user codes. It can be easily changed to shared use functionality with a Programming Key.
- In shared use, the lock is designed for day use applications. The user chooses an available storage unit and operates it with a self-selected user credential code. Once the storage unit is vacated, it becomes available for a different user.
- Manager Keys are programmed into the lock system by a unique Programming Key (required and sold separately, see page 16).

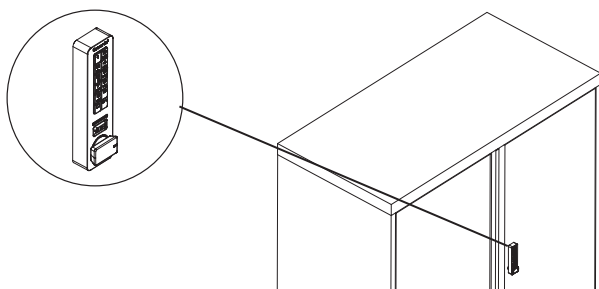

Vertical installation

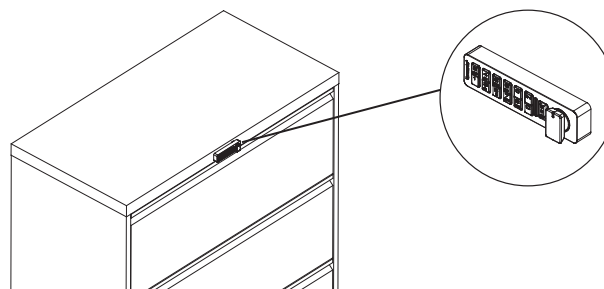

Horizontal installation

SPECIFICATIONS

LATERAL FILES

- 15 different configurations are possible; 2, 3, 4, 5 or 6-high, 30" W (762 mm), 36" W (914 mm) or 42" W (1067 mm) and 18" D (457 mm).
- Drawers come with a fixed front (D) or a receding front and a roll-out shelf (R).
- A posting shelf (P) at a height of 40" (1016 mm) is available in option to make reading and filing easier. Offered on 4, 5 and 6-drawer files.
- On all configurations, the 1st drawer from the bottom has a fixed front (D). The 5th drawer has a receding front with a roll-out shelf (R). The 6th drawer has a receding front and a fixed shelf (F).

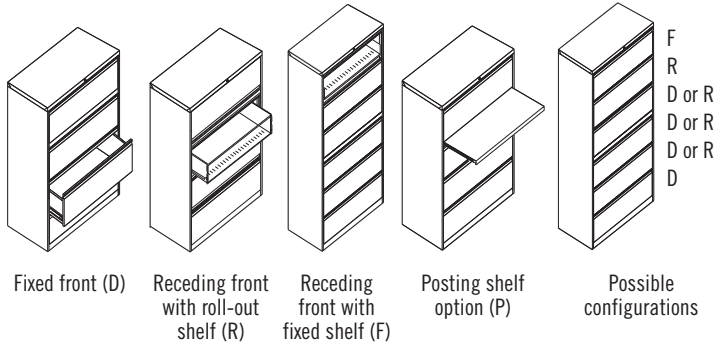

- Drawers are 12" H (305 mm) and can accommodate letter, legal or A4-size documents.
- In order to meet ANSI/BIFMA stability standards, lateral file must be installed under a work surface, be attached or have a counterweight (not required for 5 or 6-drawer files).
- A lock is installed above the highest drawer, allowing to lock all drawers at once.

- Drawers and roll-out shelves are equipped with full-extension telescopic slides. The ball-bearing system is designed to support intensive use.
- The 2-drawer file is also offered in universal height that fits under a 28" H (711 mm) work surface. That file doesn't offer the same visual compatibility when side-to-side with other units from this collection.
- Label holder included on each integrated pull for easy identification.
- Two hanging bars are included with each drawer to allow side-to-side filing. For front-to-back filing and dividers, see page 16.

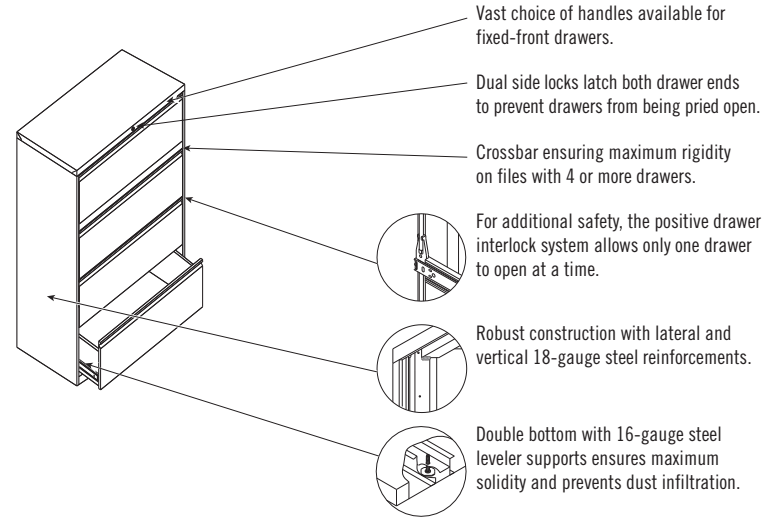

CABINETS AND BOOKCASES

- 15 different configurations are possible; 2, 3, 4, 5 or 6 compartments high, 30" W (762 mm), 36" W (914 mm) or 42" W (1067 mm) and 18" D (457 mm).
- A half-height lock is installed on the right door of the cabinet and allows to lock the 2 doors, from the bottom up.
- Interior space allows to store standard binders on all shelves except one (ex.: a 4-compartment cabinet or bookcase can hold binders on 3 shelves only).
- Shelves are adjustable every 1½" (38 mm). Additional shelves are available (see page 15).

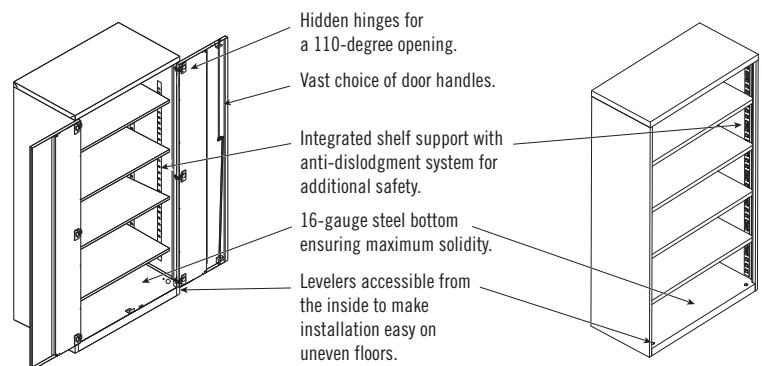

WARDROBES

- 8 different configurations are possible; hinges on left/right, 53 $\frac{3}{8}$ " H (1356 mm) and 65 $\frac{1}{2}$ " H (1664 mm), 15" W (381 mm) or 18" W (457 mm) and 24" D (610 mm).
- A half-height lock is installed on the door.
- A fixed shelf with a clothing hanger bar is located at 7 $\frac{1}{2}$ " H (191mm) from the top and allows the storage of personal effects.

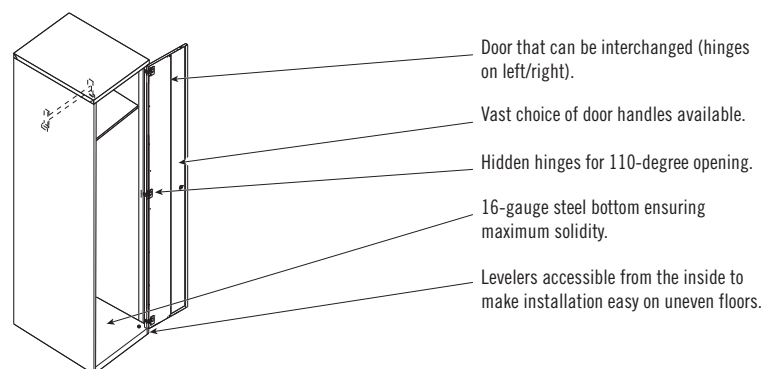

CABINETS / LATERAL FILES COMBOS

- 12 different configurations are possible; 2, 3, 4 or 5 compartments high, 30" W (762 mm), 36" W (914 mm) or 42" W (1067 mm) and 18" D (457 mm).
- In order to meet ANSI/BIFMA stability standards, 53 $\frac{3}{8}$ " H (1356 mm) or less cabinets/files must be attached or have a counterweight.
- Two independent locks for cabinet and drawers.
- Drawers are equipped with full-extension telescopic slides. The ball-bearing system is designed to support intensive use.
- Label holder included on each integrated pull for easy identification.
- Two hanging bars are included with each drawer to allow side-to-side filing. For front-to-back filing and dividers, see page 16.
- Shelves are adjustable every 1 $\frac{1}{2}$ " (38 mm). Additional shelves are available (see page 15).

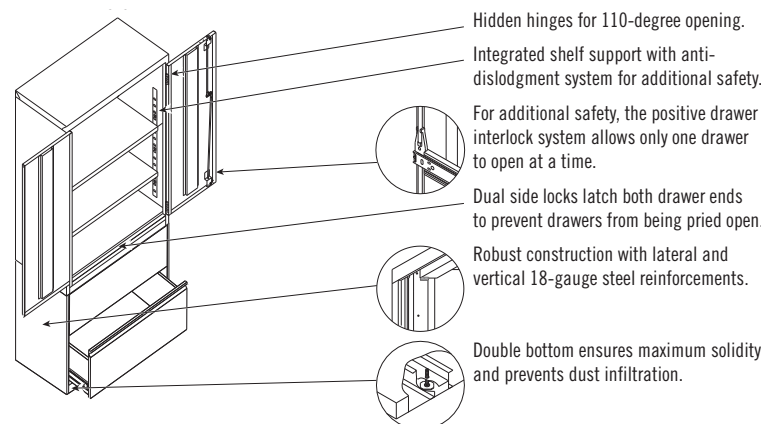

MULTIFUNCTION FILES

- 6 different configurations are possible; left or right box drawers, 30" W (762 mm), 36" W (914 mm) or 42" W (1067 mm) and 18" D (457 mm).
- In order to meet ANSI/BIFMA stability standards, multifunction files must be installed under a work surface, be attached or have a counterweight.
- Box drawers width is 12" (305 mm) for a 30" W (914 mm) unit, 18" (457 mm) for a 36" W (914 mm) unit, and 24" (610 mm) for a 42" W (1067 mm) unit.
- Central lock locks all drawers at once.
- Pencil tray included in the first box drawer.
- Label holder included on each integrated pull of lateral file drawer for easy identification.
- Two hanging bars are included with file drawers to allow side-to-side filing. For front-to-back filing and dividers, see page 16.
- Laminate tops and cushions are available. See pages 13 and 15.

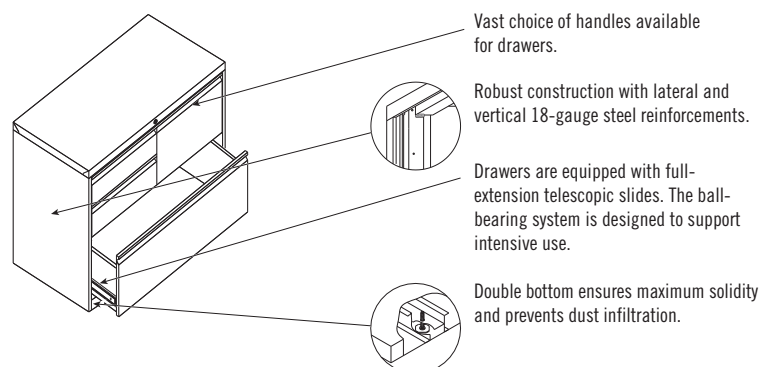

SPECIFICATIONS

COMBINED TOWERS

- 32 different configurations are possible with a cabinet or bookcase combined with box and file drawers, with or without a wardrobe; 53 ³/₈" (1356 mm) and 65 ¹/₂" (1664 mm) in height, with a width of 14 ³/₄" (375 mm) or 23 ³/₄" (604 mm).
- The wardrobe, cabinet and pedestal each have their own lock, making it possible to lock each compartment independently.
- The drawers are equipped with full-extension telescopic slides. The ball bearing system is designed to support intensive use.
- Combined towers with a height of 53 ³/₈" (1356 mm) include 1 shelf, adjustable each 1 ¹/₂" (38 mm). Combined towers with a height of 65 ¹/₂" (1664 mm) include 2 shelves.
- Wardrobe and cabinet open outward. Cabinet hinges are interchangeable. Wardrobe has a clothing hanger bar.
- Pencil tray included in the first box drawer, and two hanging bars to allow side-to-side filing are included in each file drawer.
- Label holder included on each integrated file drawer pull for easy identification.

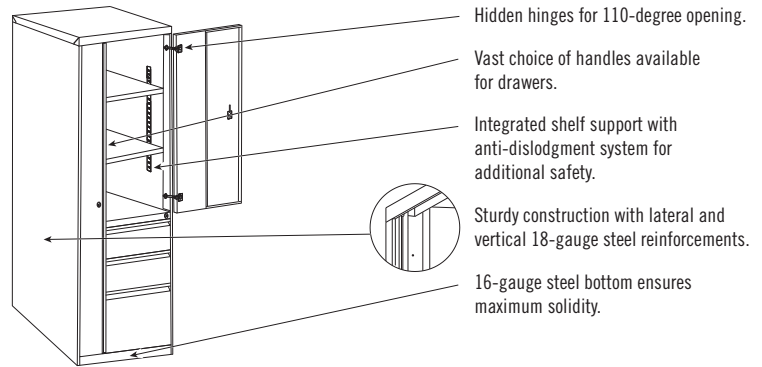

VERTICAL FILES

- 8 different configurations are possible; 2, 3, 4 or 5-high, 14 ³/₄" W (375 mm) or 17 ³/₄" W (451 mm) and 28" D (711 mm).
- In order to meet ANSI/BIFMA stability standards, vertical files with 3 or less drawers must be attached or have a counterweight.
- Drawers are 12" H (305 mm) and can accommodate letter, legal or A4-size documents. They are available with fixed front (D).
- A lock is installed above the highest drawer, allowing to lock all drawers at once.
- Label holder included on each integrated pull for easy identification.
- Full-height sides of drawers allow front-rear filing. For dividers and compressors, see page 16.

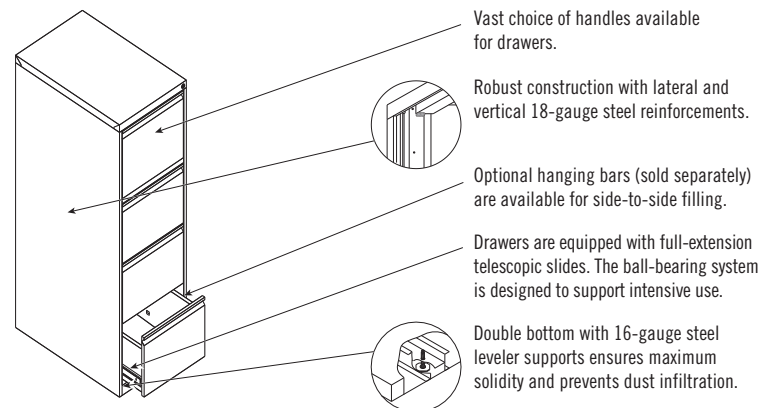

PEDESTALS

- 15 different configurations are possible: 3 drawer configurations with a depth of 18" (457 mm), 22" (559 mm) and 28" (711 mm). Offered on glides or casters.
- The pedestals meet ANSI/BIFMA stability standards and include a counterweight when necessary.
- The fixed pedestal has a box drawer with a height of 6" (152 mm) and a file drawer with a height of 12" (305 mm).
- The mobile pedestal has a box drawer with a height of 5 ¹/₂" (140 mm) and a file drawer with a height of 11" (279 mm).
- A single lock locks all drawers simultaneously.
- Pencil tray included in the first box drawer, and two hanging bars to allow side-to-side filing are included in each file drawer.
- Label holder included on each integrated file drawer pull for easy identification.
- For dividers and compressors, see page 16.
- The mobile pedestal can receive a cushion (RINNN-CU _ _ _ _).

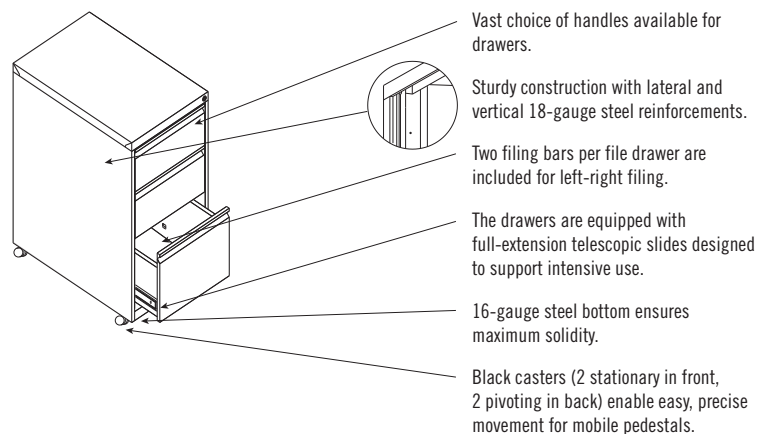

METAL STORAGE FURNITURE

SPECIFICATIONS

INTEGRATED PULLS



F – Full



R – Recessed
Non-painted
aluminum

EXTERNAL PULLS



K – Classic

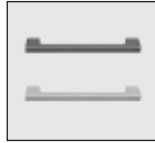

Z – Straight



M – Modern



W – Modern
White

ACCENT COLORS



A – Anthracite Grey

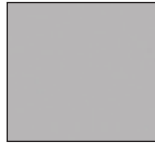

S – Silver

LOCKS



Standard



D – Electronic
Black or Nickel

LACASSE QUICKSHIP PROGRAM*

Products and suggested layouts identified by this pictogram are part of the Lacasse quick delivery program.

Please refer to page 2 for complete program details.

* Due to current market conditions, always refer to our Lead-Time Guide for a confirmation of our current Lacasse QuickShip lead-times.



CODIFICATION

Series	Options		
	Drawers	Pulls	Accent
RI	D Fixed front(s) R Recessed front(s)	F Full R Recessed Z Straight K Classic M Modern W White modern	A Anthracite Grey S Silver

OPTIONS INTEGRATION

Electronic lock: indicate **D** at the end of the code and add **\$624** to price.

Ex: **RIDFA-184254LF4D**

Counterweight: indicate **W** at the end of the code and add **\$260** to price. Factory installed.

Ex: **RIDFA-183028LF2W**

Posting shelf for lateral files with 4 or more drawers: indicate **P** at the end of the code and add **\$275** to price. Ex: **RIDFA-183054LF4P**

METAL STORAGE FURNITURE - PAINT COLORS

Standard Colors

P01 Crystal Black	P44 Metallic Silver
P04 Charcoal	P53 Snow
P17 Beige	P54 Chalk
P28 Anthracite Grey	P55 Arctic Grey
P29 Willow Grey	P57 Storm
P30 Grey Tone	P58 Velvet
P42 Smoke	

Trendy Colors*

P70 Red	P75 Aqua
P71 Orange	P76 Chartreuse
P72 Yellow	P77 Emerald
P73 Blue	P78 Midnight Blue
P74 Plum	

* Add 10% to unit price including upcharge for posting (P) shelf option, if applicable. Paint upcharge is not applicable on options such as electronic lock or counterweight.

TOP - THERMOFUSED LAMINATE / HIGH-PRESSURE LAMINATE FINISHES

Wood Grain Finishes

ATH Authentik Elm
BOR Borealis
BUC Bourbon Cherry
CER Cherry
CCL Classic Chocolate
DCH Dark Chocolate
ERH Hard Rock Maple
FOS Fossil
HRG Heritage
HZN Hazelnut
KAR Karoo
MJV Mojave
NGA Niagara
NTL Natural Cherry

(cont'd)

RAS Roots
SAH Sahara
SLT Salta
TOM Totem
TWT Tuscany Walnut

Solid Colors

GAN Anthracite Grey
NCN Crystal Black
SNO Snow
WGR Willow Grey

Patterns

GVR Frost

TOP - EDGEBANDING

N Edge



Smooth, 1/16" (1,5 mm) thick edge.

The **N** edge is matched with the finish specified for the surface.



CODIFICATION



Series	Options	
	Finishes / thickness	Edgebanding
R	1 Thermofused laminate top 1" 2 High-pressure laminate top 1" 5 Thermofused laminate top 1½" 6 High-pressure laminate top 1½"	N Smooth edge

CUSHIONS - CHOICE OF UPHOLSTERY

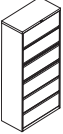
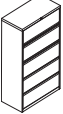
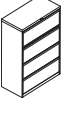
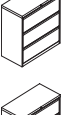



Several choices of upholstery are available. Please refer to the United Chair® Standard Upholstery Program.



METAL STORAGE FURNITURE

	W x D x H (in)	W x D x H (mm)	Code	Price (\$)
LATERAL FILES				
Fixed-front lateral files - integrated pulls	<i>The 5th drawer has a receding front with a roll-out shelf. The 6th drawer has a receding front with a fixed shelf. In order to comply with ANSI/BIFMA, a counterweight or anchoring solution is required for files with 4 or less drawers.</i>			
	6-high.			
	42 x 18 x 77 ⁵ / ₈	1067 x 457 x 1972	RID__-184278LF6	4,254
	36 x 18 x 77 ⁵ / ₈	914 x 457 x 1972	RID__-183678LF6	3,504
	30 x 18 x 77 ⁵ / ₈	762 x 457 x 1972	RID__-183078LF6	3,393
	Fixed fronts (D). Specify the pull code (F, R). Specify the accent color (A, S).			
	5-high.			
	42 x 18 x 65 ¹ / ₂	1067 x 457 x 1664	RID__-184266LF5	3,393
	36 x 18 x 65 ¹ / ₂	914 x 457 x 1664	RID__-183666LF5	2,636
	30 x 18 x 65 ¹ / ₂	762 x 457 x 1664	RID__-183066LF5	2,567
	Fixed fronts (D). Specify the pull code (F, R). Specify the accent color (A, S).			
	4-high.			
	42 x 18 x 53 ³ / ₈	1067 x 457 x 1356	RID__-184254LF4	2,628
	36 x 18 x 53 ³ / ₈	914 x 457 x 1356	RID__-183654LF4	2,137
	30 x 18 x 53 ³ / ₈	762 x 457 x 1356	RID__-183054LF4	2,124
	Fixed fronts (D). Specify the pull code (F, R). Specify the accent color (A, S).			
	3-high.			
	42 x 18 x 40 ¹ / ₁₆	1067 x 457 x 1018	RID__-184241LF3	2,086
	36 x 18 x 40 ¹ / ₁₆	914 x 457 x 1018	RID__-183641LF3	1,701
	30 x 18 x 40 ¹ / ₁₆	762 x 457 x 1018	RID__-183041LF3	1,648
	Fixed fronts (D). Specify the pull code (F, R). Specify the accent color (A, S).			
	2-high.			
	42 x 18 x 27 ¹ / ₈	1067 x 457 x 708	RID__-184228LF2	1,507
	36 x 18 x 27 ¹ / ₈	914 x 457 x 708	RID__-183628LF2	1,269
	30 x 18 x 27 ¹ / ₈	762 x 457 x 708	RID__-183028LF2	1,165
	Fixed fronts (D). Specify the pull code (F, R). Specify the accent color (A, S).			
	2-high, universal height.			
	42 x 18 x 26 ⁷ / ₈	1067 x 457 x 683	RID__-184227LF2	1,507
	36 x 18 x 26 ⁷ / ₈	914 x 457 x 683	RID__-183627LF2	1,269
	30 x 18 x 26 ⁷ / ₈	762 x 457 x 683	RID__-183027LF2	1,165
	Fixed fronts (D). Specify the pull code (F, R). Specify the accent color (A, S).			

Electronic lock option (D): add \$624.				
Counterweight option (W): add \$260.				
Posting shelf option (P)*: add \$275.				
*Available on file with 4 and more drawers.				
Fixed-front lateral files - external pulls	<i>In order to comply with ANSI/BIFMA, a counterweight or anchoring solution is required.</i>			
	4-high.			
	42 x 18 x 53 ³ / ₈	1067 x 457 x 1356	RID__-184254LF4	2,628
	36 x 18 x 53 ³ / ₈	914 x 457 x 1356	RID__-183654LF4	2,137
	30 x 18 x 53 ³ / ₈	762 x 457 x 1356	RID__-183054LF4	2,124
	Fixed fronts (D). Specify the pull code (K, M, Z, W). Specify the accent color (A, S).			
	3-high.			
	42 x 18 x 40 ¹ / ₁₆	1067 x 457 x 1018	RID__-184241LF3	2,086
	36 x 18 x 40 ¹ / ₁₆	914 x 457 x 1018	RID__-183641LF3	1,701
	30 x 18 x 40 ¹ / ₁₆	762 x 457 x 1018	RID__-183041LF3	1,648
	Fixed fronts (D). Specify the pull code (K, M, Z, W). Specify the accent color (A, S).			
Electronic lock option (D): add \$624.				
Counterweight option (W): add \$260.				
Posting shelf option (P)*: add \$275.				
*Available on file with 4 drawers.				

	W x D x H (in)	W x D x H (mm)	Code	Price (\$)
Fixed-front lateral files - external pulls (cont'd)	2-high.			
	42 x 18 x 27 ¹ / ₈	1067 x 457 x 708	RID__-184228LF2	1,507
	36 x 18 x 27 ¹ / ₈	914 x 457 x 708	RID__-183628LF2	1,269
	30 x 18 x 27 ¹ / ₈	762 x 457 x 708	RID__-183028LF2	1,165
	Fixed fronts (D). Specify the pull code (K, M, Z, W). Specify the accent color (A, S).			
	2-high, universal height.			
	42 x 18 x 26 ⁷ / ₈	1067 x 457 x 683	RID__-184227LF2	1,507
	36 x 18 x 26 ⁷ / ₈	914 x 457 x 683	RID__-183627LF2	1,269
	30 x 18 x 26 ⁷ / ₈	762 x 457 x 683	RID__-183027LF2	1,165
	Fixed fronts (D). Specify the pull code (K, M, Z, W). Specify the accent color (A, S).			

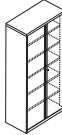
Receding-front lateral files - integrated pulls	<i>The 1st drawer from the bottom has a fixed front. The 6th drawer has a receding front with a fixed shelf. In order to comply with ANSI/BIFMA, a counterweight or anchoring solution is required for files with 4 or less drawers.</i>			
	6-high.			
	42 x 18 x 77 ⁵ / ₈	1067 x 457 x 1972	RIR__-184278LF6	4,500
	36 x 18 x 77 ⁵ / ₈	914 x 457 x 1972	RIR__-183678LF6	4,135
	30 x 18 x 77 ⁵ / ₈	762 x 457 x 1972	RIR__-183078LF6	4,104
	Receding fronts (R). Specify the pull code (F, R). Specify the accent color (A, S).			
	5-high.			
	42 x 18 x 65 ¹ / ₂	1067 x 457 x 1664	RIR__-184266LF5	3,793
	36 x 18 x 65 ¹ / ₂	914 x 457 x 1664	RIR__-183666LF5	3,266
	30 x 18 x 65 ¹ / ₂	762 x 457 x 1664	RIR__-183066LF5	3,208
	Receding fronts (R). Specify the pull code (F, R). Specify the accent color (A, S).			
	4-high.			
	42 x 18 x 53 ³ / ₈	1067 x 457 x 1356	RIR__-184254LF4	3,141
	36 x 18 x 53 ³ / ₈	914 x 457 x 1356	RIR__-183654LF4	2,718
	30 x 18 x 53 ³ / ₈	762 x 457 x 1356	RIR__-183054LF4	2,525
	Receding fronts (R). Specify the pull code (F, R). Specify the accent color (A, S).			
	3-high.			
	42 x 18 x 40 ¹ / ₁₆	1067 x 457 x 1018	RIR__-184241LF3	2,435
	36 x 18 x 40 ¹ / ₁₆	914 x 457 x 1018	RIR__-183641LF3	2,181
	30 x 18 x 40 ¹ / ₁₆	762 x 457 x 1018	RIR__-183041LF3	2,159
	Receding fronts (R). Specify the pull code (F, R). Specify the accent color (A, S).			
Electronic lock option (D): add \$624.				
Counterweight option (W): add \$260.				
Posting shelf option (P)*: add \$275.				
*Available on file with 4 and more drawers.				

	W x D x H (in)	W x D x H (mm)	Code	Price (\$)
CABINETS				
Cabinets - integrated pulls	<i>6 compartments (5 adjustable shelves).</i>			
	42 x 18 x 77 ⁵ / ₈	1067 x 457 x 1972	RIN__-421878B	2,548
	36 x 18 x 77 ⁵ / ₈	914 x 457 x 1972	RIN__-361878B	2,414
	30 x 18 x 77 ⁵ / ₈	762 x 457 x 1972	RIN__-301878B	2,272
	Specify the pull code (F, R). Specify the accent color (A, S).			
	<i>5 compartments (4 adjustable shelves).</i>			
	42 x 18 x 65 ¹ / ₂	1067 x 457 x 1664	RIN__-421866B	2,107
	36 x 18 x 65 ¹ / ₂	914 x 457 x 1664	RIN__-361866B	1,960
	30 x 18 x 65 ¹ / ₂	762 x 457 x 1664	RIN__-301866B	1,886
	Specify the pull code (F, R). Specify the accent color (A, S).			

	W x D x H (in)	W x D x H (mm)	Code	Price (\$)
Cabinets - integrated pulls (cont'd)	<i>4 compartments (3 adjustable shelves).</i>			
	42 x 18 x 53 ³ / ₈	1067 x 457 x 1356	RIN__-421854B	1,833
	36 x 18 x 53 ³ / ₈	914 x 457 x 1356	RIN__-361854B	1,701
	30 x 18 x 53 ³ / ₈	762 x 457 x 1356	RIN__-301854B	1,633
	Specify the pull code (F, R). Specify the accent color (A, S).			
	<i>3 compartments (2 adjustable shelves).</i>			
	42 x 18 x 40 ¹ / ₁₆	1067 x 457 x 1018	RIN__-421841B	1,582
	36 x 18 x 40 ¹ / ₁₆	914 x 457 x 1018	RIN__-361841B	1,462
	30 x 18 x 40 ¹ / ₁₆	762 x 457 x 1018	RIN__-301841B	1,402
	Specify the pull code (F, R). Specify the accent color (A, S).			
	<i>2 compartments (1 adjustable shelf).</i>			
	42 x 18 x 27 ¹ / ₈	1067 x 457 x 708	RIN__-421828B	1,277
	36 x 18 x 27 ¹ / ₈	914 x 457 x 708	RIN__-361828B	1,203
	30 x 18 x 27 ¹ / ₈	762 x 457 x 708	RIN__-301828B	1,165
	Specify the pull code (F, R). Specify the accent color (A, S).			

Cabinets - external pulls	<i>6 compartments (5 adjustable shelves).</i>			
	42 x 18 x 77 ¹ / ₈	1067 x 457 x 1972	RIN__-421878B	2,548
	36 x 18 x 77 ¹ / ₈	914 x 457 x 1972	RIN__-361878B	2,414
	30 x 18 x 77 ¹ / ₈	762 x 457 x 1972	RIN__-301878B	2,272
	Specify the pull code (K, M, Z, W). Specify the accent color (A, S).			
	<i>5 compartments (4 adjustable shelves).</i>			
	42 x 18 x 65 ¹ / ₂	1067 x 457 x 1664	RIN__-421866B	2,107
	36 x 18 x 65 ¹ / ₂	914 x 457 x 1664	RIN__-361866B	1,960
	30 x 18 x 65 ¹ / ₂	762 x 457 x 1664	RIN__-301866B	1,886
	Specify the pull code (K, M, Z, W). Specify the accent color (A, S).			
	<i>4 compartments (3 adjustable shelves).</i>			
	42 x 18 x 53 ³ / ₈	1067 x 457 x 1356	RIN__-421854B	1,833
	36 x 18 x 53 ³ / ₈	914 x 457 x 1356	RIN__-361854B	1,701
	30 x 18 x 53 ³ / ₈	762 x 457 x 1356	RIN__-301854B	1,633
	Specify the pull code (K, M, Z, W). Specify the accent color (A, S).			
	<i>3 compartments (2 adjustable shelves).</i>			
	42 x 18 x 40 ¹ / ₁₆	1067 x 457 x 1018	RIN__-421841B	1,582
	36 x 18 x 40 ¹ / ₁₆	914 x 457 x 1018	RIN__-361841B	1,462
	30 x 18 x 40 ¹ / ₁₆	762 x 457 x 1018	RIN__-301841B	1,402
	Specify the pull code (K, M, Z, W). Specify the accent color (A, S).			
	<i>2 compartments (1 adjustable shelf).</i>			
	42 x 18 x 27 ¹ / ₈	1067 x 457 x 708	RIN__-421828B	1,277
	36 x 18 x 27 ¹ / ₈	914 x 457 x 708	RIN__-361828B	1,203
	30 x 18 x 27 ¹ / ₈	762 x 457 x 708	RIN__-301828B	1,165
	Specify the pull code (K, M, Z, W). Specify the accent color (A, S).			

BOOKCASES

Bookcases	<i>6 compartments (5 adjustable shelves).</i>			
	42 x 18 x 77 ¹ / ₈	1067 x 457 x 1972	RINNN-B427818	2,131
	36 x 18 x 77 ¹ / ₈	914 x 457 x 1972	RINNN-B367818	1,974
	<i>30 x 18 x 77¹/₈</i>			
	<i>762 x 457 x 1972</i>			
	<i>RINNN-B307818</i>			
	<i>1,862</i>			
	<i>5 compartments (4 adjustable shelves).</i>			
	42 x 18 x 65 ¹ / ₂	1067 x 457 x 1664	RINNN-B426618	1,685
	36 x 18 x 65 ¹ / ₂	914 x 457 x 1664	RINNN-B366618	1,448
	30 x 18 x 65 ¹ / ₂	762 x 457 x 1664	RINNN-B306618	1,352
	<i>4 compartments (3 adjustable shelves).</i>			
	42 x 18 x 53 ³ / ₈	1067 x 457 x 1356	RINNN-B425418	1,343
	36 x 18 x 53 ³ / ₈	914 x 457 x 1356	RINNN-B365418	1,247
	30 x 18 x 53 ³ / ₈	762 x 457 x 1356	RINNN-B305418	1,158

	W x D x H (in)	W x D x H (mm)	Code	Price (\$)
Bookcases (cont'd)	<i>3 compartments (2 adjustable shelves).</i>			
	42 x 18 x 40 ¹ / ₁₆	1067 x 457 x 1018	RINNN-B424118	1,129
	36 x 18 x 40 ¹ / ₁₆	914 x 457 x 1018	RINNN-B364118	1,011
	<i>30 x 18 x 40¹/₁₆</i>			
	<i>762 x 457 x 1018</i>			
	<i>RINNN-B304118</i>			
	<i>949</i>			
	<i>2 compartments (1 adjustable shelf).</i>			
	42 x 18 x 27 ¹ / ₈	1067 x 457 x 708	RINNN-B422818	966
	36 x 18 x 27 ¹ / ₈	914 x 457 x 708	RINNN-B362818	889
	30 x 18 x 27 ¹ / ₈	762 x 457 x 708	RINNN-B302818	854

WARDROBES



Wardrobes - integrated pulls	<i>18" (457 mm) wide.</i>			
	18 x 24 x 65 ¹ / ₂	457 x 610 x 1664	RIN__-241866B	1,767
	18 x 24 x 53 ³ / ₈	457 x 610 x 1356	RIN__-241854B	1,618
	Specify the pull code (F, R). Specify the accent color (A, S). Specify the door opening at the end of the code: hinges on left (L) or hinges on right (R).			
	<i>15" (381 mm) wide.</i>			
	15 x 24 x 65 ¹ / ₂	381 x 610 x 1664	RIN__-241566B	1,514
	15 x 24 x 53 ³ / ₈	381 x 610 x 1356	RIN__-241554B	1,438
	Specify the pull code (F, R). Specify the accent color (A, S). Specify the door opening at the end of the code: hinges on left (L) or hinges on right (R).			

Wardrobes - external pulls	<i>18" (457 mm) wide.</i>			
	18 x 24 x 65 ¹ / ₂	457 x 610 x 1664	RIN__-241866B	1,767
	18 x 24 x 53 ³ / ₈	457 x 610 x 1356	RIN__-241854B	1,618
	Specify the pull code (K, M, Z, W). Specify the accent color (A, S). Specify the door opening at the end of the code: hinges on left (L) or hinges on right (R).			
	<i>15" (381 mm) wide.</i>			
	15 x 24 x 65 ¹ / ₂	381 x 610 x 1664	RIN__-241566B	1,514
	15 x 24 x 53 ³ / ₈	381 x 610 x 1356	RIN__-241554B	1,438
	Specify the pull code (K, M, Z, W). Specify the accent color (A, S). Specify the door opening at the end of the code: hinges on left (L) or hinges on right (R).			

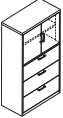
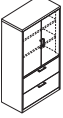
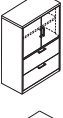

MULTIFUNCTION STORAGE FURNITURE

Cabinets / Lateral Files Combos - integrated pulls	<i>In order to comply with ANSI/BIFMA standards, a counterweight or anchoring solution is required on storage units 53³/₈" H (1356 mm) or less.</i>			
	<i>3 full width drawers, closed cabinet 23" H (584 mm) with 1 adjustable shelf.</i>			
	42 x 18 x 65 ¹ / ₂	1067 x 457 x 1664	RID__-184266LF3B	3,734
	36 x 18 x 65 ¹ / ₂	914 x 457 x 1664	RID__-183666LF3B	3,288
	30 x 18 x 65 ¹ / ₂	762 x 457 x 1664	RID__-183066LF3B	3,221
	Fixed fronts (D). Specify the pull code (F, R). Specify the accent color (A, S).			
	<i>2 full width drawers, closed cabinet 35" H (889 mm) with 2 adjustable shelves.</i>			
	42 x 18 x 65 ¹ / ₂	1067 x 457 x 1664	RID__-184266LF2B	3,497
	36 x 18 x 65 ¹ / ₂	914 x 457 x 1664	RID__-183666LF2B	3,117
	30 x 18 x 65 ¹ / ₂	762 x 457 x 1664	RID__-183066LF2B	2,970
	Fixed fronts (D). Specify the pull code (F, R). Specify the accent color (A, S).			
	<i>2 full width drawers, closed cabinet 23" H (584 mm) with 1 adjustable shelf.</i>			
	42 x 18 x 53 ³ / ₈	1067 x 457 x 1356	RID__-184254LF2B	3,162
	36 x 18 x 53 ³ / ₈	914 x 457 x 1356	RID__-183654LF2B	2,822
	30 x 18 x 53 ³ / ₈	762 x 457 x 1356	RID__-183054LF2B	2,754
	Fixed fronts (D). Specify the pull code (F, R). Specify the accent color (A, S).			
	<i>1 full width drawer, closed cabinet 23" H (584 mm) with 1 adjustable shelf.</i>			
	42 x 18 x 40 ¹ / ₁₆	1067 x 457 x 1018	RID__-184241LFB	3,015
	36 x 18 x 40 ¹ / ₁₆	914 x 457 x 1018	RID__-183641LFB	2,567
	30 x 18 x 40 ¹ / ₁₆	762 x 457 x 1018	RID__-183041LFB	2,502
	Fixed fronts (D). Specify the pull code (F, R). Specify the accent color (A, S).			

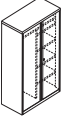

METAL STORAGE FURNITURE

	W x D x H (in)	W x D x H (mm)	Code	Price (\$)
Cabinets / Lateral Files Combos - external pulls				
<i>In order to comply with ANSI/BIFMA standards, a counterweight or anchoring solution is required on storage units 53 3/8" H (1356 mm) or less.</i>				
<i>3 full width drawers, closed cabinet 23" H (584 mm) with 1 adjustable shelf.</i>				
	42 x 18 x 65 1/2	1067 x 457 x 1664	RID__-184266LF3B	3,734
	36 x 18 x 65 1/2	914 x 457 x 1664	RID__-183666LF3B	3,288
	30 x 18 x 65 1/2	762 x 457 x 1664	RID__-183066LF3B	3,221
Fixed fronts (D). Specify the pull code (K, M, Z, W). Specify the accent color (A, S).				
<i>2 full width drawers, closed cabinet 35" H (889 mm) with 2 adjustable shelves.</i>				
	42 x 18 x 65 1/2	1067 x 457 x 1664	RID__-184266LF2B	3,497
	36 x 18 x 65 1/2	914 x 457 x 1664	RID__-183666LF2B	3,117
	30 x 18 x 65 1/2	762 x 457 x 1664	RID__-183066LF2B	2,970
Fixed fronts (D). Specify the pull code (K, M, Z, W). Specify the accent color (A, S).				
<i>2 full width drawers, closed cabinet 23" H (584 mm) with 1 adjustable shelf.</i>				
	42 x 18 x 53 3/8	1067 x 457 x 1356	RID__-184254LF2B	3,162
	36 x 18 x 53 3/8	914 x 457 x 1356	RID__-183654LF2B	2,822
	30 x 18 x 53 3/8	762 x 457 x 1356	RID__-183054LF2B	2,754
Fixed fronts (D). Specify the pull code (K, M, Z, W). Specify the accent color (A, S).				
<i>1 full width drawer, closed cabinet 23" H (584 mm) with 1 adjustable shelf.</i>				
	42 x 18 x 40 7/16	1067 x 457 x 1018	RID__-184241LFB	3,015
	36 x 18 x 40 7/16	914 x 457 x 1018	RID__-183641LFB	2,567
	30 x 18 x 40 7/16	762 x 457 x 1018	RID__-183041LFB	2,516
Fixed fronts (D). Specify the pull code (K, M, Z, W). Specify the accent color (A, S).				

Counterweight option (W): add \$260.

Cabinets / Wardrobes Combos - integrated pulls				
<i>1 full width fixed shelf, 1 clothes hanger bar, 4 adjustable half shelves.</i>				
	42 x 18 x 77 3/8	1067 x 457 x 1972	RIN__-421878BC	3,015
	36 x 18 x 77 3/8	914 x 457 x 1972	RIN__-361878BC	2,844
	30 x 18 x 77 3/8	762 x 457 x 1972	RIN__-301878BC	2,775
Specify the pull code (F, R). Specify the accent color (A, S).				
<i>1 full width fixed shelf, 1 clothes hanger bar, 3 adjustable half shelves.</i>				
	42 x 18 x 65 1/2	1067 x 457 x 1664	RIN__-421866BC	2,926
	36 x 18 x 65 1/2	914 x 457 x 1664	RIN__-361866BC	2,775
	30 x 18 x 65 1/2	762 x 457 x 1664	RIN__-301866BC	2,731
Specify the pull code (F, R). Specify the accent color (A, S).				

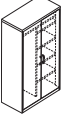
Electronic lock option (D): add \$624.

Cabinets / Wardrobes Combos - external pulls				
<i>1 full width fixed shelf, 1 clothes hanger bar, 4 adjustable half shelves.</i>				
	42 x 18 x 77 3/8	1067 x 457 x 1972	RIN__-421878BC	3,015
	36 x 18 x 77 3/8	914 x 457 x 1972	RIN__-361878BC	2,844
	30 x 18 x 77 3/8	762 x 457 x 1972	RIN__-301878BC	2,775
Specify the pull code (K, M, Z, W). Specify the accent color (A, S).				
<i>1 full width fixed shelf, 1 clothes hanger bar, 3 adjustable half shelves.</i>				
	42 x 18 x 65 1/2	1067 x 457 x 1664	RIN__-421866BC	2,926
	36 x 18 x 65 1/2	914 x 457 x 1664	RIN__-361866BC	2,775
	30 x 18 x 65 1/2	762 x 457 x 1664	RIN__-301866BC	2,731
Specify the pull code (K, M, Z, W). Specify the accent color (A, S).				

Electronic lock option (D): add \$624.

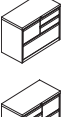
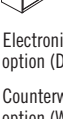
Multifunction files - integrated pulls				
<i>In order to comply with ANSI/BIFMA standards, a counterweight or anchoring solution is required.</i>				
<i>1 full width file drawer, 1 file drawer on left, 2 box drawers on right.</i>				
	42 x 18 x 27 1/8	1067 x 457 x 708	RID__-C0184228	2,295
	36 x 18 x 27 1/8	914 x 457 x 708	RID__-C0183628	2,101
	30 x 18 x 27 1/8	762 x 457 x 708	RID__-C0183028	2,055
Fixed fronts (D). Specify the pull code (F, R). Specify the accent color (A, S).				
<i>1 full width file drawer, 1 file drawer on right, 2 box drawers on left.</i>				
	42 x 18 x 27 1/8	1067 x 457 x 708	RID__-184228CO	2,295
	36 x 18 x 27 1/8	914 x 457 x 708	RID__-183628CO	2,101
	30 x 18 x 27 1/8	762 x 457 x 708	RID__-183028CO	2,055
Fixed fronts (D). Specify the pull code (F, R). Specify the accent color (A, S).				

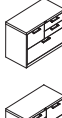
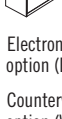

Electronic lock option (D): add \$624.

Counterweight option (W): add \$260.

	W x D x H (in)	W x D x H (mm)	Code	Price (\$)
Multifunction files - external pulls				
<i>In order to comply with ANSI/BIFMA standards, a counterweight or anchoring solution is required on storage units.</i>				
<i>1 full width file drawer, 1 file drawer on left, 2 box drawers on right.</i>				
	42 x 18 x 27 1/8	1067 x 457 x 708	RID__-C0184228	2,295
	36 x 18 x 27 1/8	914 x 457 x 708	RID__-C0183628	2,101
	30 x 18 x 27 1/8	762 x 457 x 708	RID__-C0183028	2,055
Fixed fronts (D). Specify the pull code (K, M, Z, W). Specify the accent color (A, S).				
<i>1 full width file drawer, 1 file drawer on right, 2 box drawers on left.</i>				
	42 x 18 x 27 1/8	1067 x 457 x 708	RID__-184228CO	2,295
	36 x 18 x 27 1/8	914 x 457 x 708	RID__-183628CO	2,101
	30 x 18 x 27 1/8	762 x 457 x 708	RID__-183028CO	2,055
Fixed fronts (D). Specify the pull code (K, M, Z, W). Specify the accent color (A, S).				

Electronic lock option (D): add \$624.

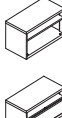
Counterweight option (W): add \$260.

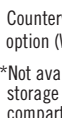
Low storage units - integrated pulls				
<i>In order to comply with ANSI/BIFMA standards, a counterweight or anchoring solution is required on storage units with drawer(s).</i>				
<i>1 bookcase compartment, 1 pigeonhole.</i>				
	36 x 18 x 21 3/4	914 x 457 x 552	RINNN-BE361822	907
	30 x 18 x 21 3/4	762 x 457 x 552	RINNN-BE301822	832
Fixed fronts (D). Specify the pull code (F, R). Specify the accent color (A, S).				
<i>1 fixed-front file drawer, 1 pigeonhole.</i>				
	36 x 18 x 21 3/4	914 x 457 x 552	RID__-SLF361822	1,418
	30 x 18 x 21 3/4	762 x 457 x 552	RID__-SLF301822	1,366
Fixed front (D). Specify the pull code (F, R). Specify the accent color (A, S).				
<i>1 file drawer, 1 fixed-front utility drawer.</i>				
	36 x 18 x 21 3/4	914 x 457 x 552	RID__-UL361822	1,514
	30 x 18 x 21 3/4	762 x 457 x 552	RID__-UL301822	1,462
Fixed fronts (D). Specify the pull code (F, R). Specify the accent color (A, S).				

Electronic lock option (D)*: add \$624

Counterweight option (W)*: add \$260.

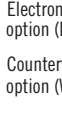

*Not available on low storage units with open compartments.

Low storage units - external pulls				
<i>In order to comply with ANSI/BIFMA standards, a counterweight or anchoring solution is required.</i>				
<i>1 fixed-front file drawer, 1 pigeonhole.</i>				
	36 x 18 x 21 3/4	914 x 457 x 552	RID__-SLF361822	1,418
	30 x 18 x 21 3/4	762 x 457 x 552	RID__-SLF301822	1,366
Fixed front (D). Specify the pull code (K, M, Z, W). Specify the accent color (A, S).				
<i>1 file drawer and 1 fixed-front utility drawer.</i>				
	36 x 18 x 21 3/4	914 x 457 x 552	RID__-UL361822	1,514
	30 x 18 x 21 3/4	762 x 457 x 552	RID__-UL301822	1,462
Fixed fronts (D). Specify the pull code (K, M, Z, W). Specify the accent color (A, S).				

Electronic lock option (D): add \$624.

Counterweight option (W): add \$260.

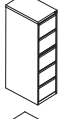
VERTICAL FILES

Vertical files - integrated pulls				
<i>In order to comply with ANSI/BIFMA standards, a counterweight or anchoring solution is required on files with 3 or less drawers.</i>				
<i>5-high.</i>				
	17 3/4 x 28 x 65 1/2	451 x 711 x 1664	RID__-281866VF5	2,317
	14 3/4 x 28 x 65 1/2	375 x 711 x 1664	RID__-281566VF5	2,317
Specify the pull code (F, R). Specify the accent color (A, S).				
<i>4-high.</i>				
	17 3/4 x 28 x 53 3/8	451 x 711 x 1356	RID__-281854VF4	1,856
	14 3/4 x 28 x 53 3/8	375 x 711 x 1356	RID__-281554VF4	1,856
Specify the pull code (F, R). Specify the accent color (A, S).				

	W x D x H (in)	W x D x H (mm)	Code	Price (\$)
Vertical files - integrated pulls (cont'd)	<i>3-high.</i>			
	17 ³ / ₄ x 28 x 40 ¹ / ₁₆	451 x 711 x 1018	RID__-281841VF3	1,625
	14 ³ / ₄ x 28 x 40 ¹ / ₁₆	375 x 711 x 1018	RID__-281541VF3	1,625
	Specify the pull code (F, R). Specify the accent color (A, S).			
	<i>2-high.</i>			
	17 ³ / ₄ x 28 x 27 ⁷ / ₈	451 x 711 x 708	RID__-281828VF2	1,165
	14 ³ / ₄ x 28 x 27 ⁷ / ₈	375 x 711 x 708	RID__-281528VF2	1,165
	Specify the pull code (F, R). Specify the accent color (A, S).			

Electronic lock option (D): add \$624.

Counterweight option (W): add \$260.

	<i>In order to comply with ANSI/BIFMA standards, a counterweight or anchoring solution is required on files with 3 or less drawers.</i>			
Vertical files - external pulls	<i>5-high.</i>			
	17 ³ / ₄ x 28 x 65 ¹ / ₂	451 x 711 x 1664	RID__-281866VF5	2,317
	14 ³ / ₄ x 28 x 65 ¹ / ₂	375 x 711 x 1664	RID__-281566VF5	2,317
	Specify the pull code (K, M, Z, W). Specify the accent color (A, S).			
	<i>4-high.</i>			
	17 ³ / ₄ x 28 x 53 ³ / ₈	451 x 711 x 1356	RID__-281854VF4	1,856
	14 ³ / ₄ x 28 x 53 ³ / ₈	375 x 711 x 1356	RID__-281554VF4	1,856
	Specify the pull code (K, M, Z, W). Specify the accent color (A, S).			
	<i>3-high.</i>			
	17 ³ / ₄ x 28 x 40 ¹ / ₁₆	451 x 711 x 1018	RID__-281841VF3	1,625
	14 ³ / ₄ x 28 x 40 ¹ / ₁₆	375 x 711 x 1018	RID__-281541VF3	1,625
	Specify the pull code (K, M, Z, W). Specify the accent color (A, S).			
	<i>2-high.</i>			
	17 ³ / ₄ x 28 x 27 ⁷ / ₈	451 x 711 x 708	RID__-281828VF2	1,165
	14 ³ / ₄ x 28 x 27 ⁷ / ₈	375 x 711 x 708	RID__-281528VF2	1,165
	Specify the pull code (K, M, Z, W). Specify the accent color (A, S).			

Electronic lock option (D): add \$624.

Counterweight option (W): add \$260.

LAMINATE TOPS

Double-faced tape included. When appropriately mounted, back-to-back tops (units with two or more drawers) or side-by-side tops (units with 3 or more drawers) are an efficient alternative to the use of counterweights.

Tops for individual storage unit	<i>Top 1" (25 mm) thick.</i>			
	42 ¹ / ₁₆ x 18 ¹ / ₁₆ x 1	1068 x 458 x 25	R_NNN-T04218	319 430
	36 ¹ / ₁₆ x 18 ¹ / ₁₆ x 1	916 x 458 x 25	R_NNN-T03618	304 394
	30 ¹ / ₁₆ x 18 ¹ / ₁₆ x 1	763 x 458 x 25	R_NNN-T03018	290 379
	Specify the finish (1, 2). Smooth edge (N).			
	<i>Top 1 1/2" (38 mm) thick.</i>			
	42 ¹ / ₁₆ x 18 ¹ / ₁₆ x 1 1/2	1068 x 458 x 38	R_NNN-T04218	430 549
	36 ¹ / ₁₆ x 18 ¹ / ₁₆ x 1 1/2	916 x 458 x 38	R_NNN-T03618	416 490
	30 ¹ / ₁₆ x 18 ¹ / ₁₆ x 1 1/2	763 x 458 x 38	R_NNN-T03018	400 461
	Specify the finish (5, 6). Smooth edge (N).			

Tops for 2 side-by-side storage units	<i>Top 1" (25 mm) thick.</i>			
	84 ¹ / ₈ x 18 ¹ / ₁₆ x 1	2136 x 458 x 25	R_NNN-T08418	430 594
	72 ¹ / ₈ x 18 ¹ / ₁₆ x 1	1832 x 458 x 25	R_NNN-T07218	394 549
	60 ¹ / ₈ x 18 ¹ / ₁₆ x 1	1526 x 458 x 25	R_NNN-T06018	364 504
	Specify the finish (1, 2). Smooth edge (N).			
	<i>Top 1 1/2" (38 mm) thick.</i>			
	84 ¹ / ₈ x 18 ¹ / ₁₆ x 1 1/2	2136 x 458 x 38	R_NNN-T08418	594 765
	72 ¹ / ₈ x 18 ¹ / ₁₆ x 1 1/2	1832 x 458 x 38	R_NNN-T07218	549 684
	60 ¹ / ₈ x 18 ¹ / ₁₆ x 1 1/2	1526 x 458 x 38	R_NNN-T06018	504 639
	Specify the finish (5, 6). Smooth edge (N).			

Tops for 2 back-to-back storage units.	<i>Top 1" (25 mm) thick.</i>			
	42 ¹ / ₁₆ x 36 ¹ / ₈ x 1	1068 x 916 x 25	R_NNN-T04236	394 571
	36 ¹ / ₁₆ x 36 ¹ / ₈ x 1	916 x 916 x 25	R_NNN-T03636	379 520
	30 ¹ / ₁₆ x 36 ¹ / ₈ x 1	763 x 916 x 25	R_NNN-T03036	349 461
	Specify the finish (1, 2). Smooth edge (N).			

	W x D x H (in)	W x D x H (mm)	Code	Dessus melamine (\$)	Dessus stratifié (\$)
Tops for 2 back-to-back storage units. (cont'd)	<i>Top 1 1/2" (38 mm) thick.</i>				
	42 ¹ / ₁₆ x 36 ¹ / ₈ x 1 1/2	1068 x 916 x 38	R_NNN-T04236	549	668
	36 ¹ / ₁₆ x 36 ¹ / ₈ x 1 1/2	916 x 916 x 38	R_NNN-T03636	535	601
	30 ¹ / ₁₆ x 36 ¹ / ₈ x 1 1/2	763 x 916 x 38	R_NNN-T03036	476	549
	Specify the finish (5, 6). Smooth edge (N).				

Tops for 4 back-to-back storage units	<i>Top 1" (25 mm) thick.</i>				
	84 ¹ / ₈ x 36 ¹ / ₈ x 1	2136 x 916 x 25	R_NNN-T08436	862	1,188
	72 ¹ / ₈ x 36 ¹ / ₈ x 1	1832 x 916 x 25	R_NNN-T07236	785	1,098
	60 ¹ / ₈ x 36 ¹ / ₈ x 1	1526 x 916 x 25	R_NNN-T06036	727	1,011
	Specify the finish (1, 2). Smooth edge (N).				

	<i>Top 1 1/2" (38 mm) thick.</i>				
	84 ¹ / ₈ x 36 ¹ / ₈ x 1 1/2	2136 x 916 x 38	R_NNN-T08436	1,188	1,530
	72 ¹ / ₈ x 36 ¹ / ₈ x 1 1/2	1832 x 916 x 38	R_NNN-T07236	1,098	1,366
	60 ¹ / ₈ x 36 ¹ / ₈ x 1 1/2	1526 x 916 x 38	R_NNN-T06036	1,011	1,277
	Specify the finish (5, 6). Smooth edge (N).				

Tops for individual storage unit - 24" D	<i>Top 1" (25 mm) thick.</i>				
	18 ¹ / ₁₆ x 24 ¹ / ₁₆ x 1	458 x 611 x 25	R_NNN-T01824	252	325
	15 ¹ / ₁₆ x 24 ¹ / ₁₆ x 1	382 x 611 x 25	R_NNN-T01524	240	304
	Specify the finish (1, 2). Smooth edge (N).				



	<i>Top 1 1/2" (38 mm) thick.</i>				
	18 ¹ / ₁₆ x 24 ¹ / ₁₆ x 1 1/2	458 x 611 x 38	R_NNN-T01824	349	416
	15 ¹ / ₁₆ x 24 ¹ / ₁₆ x 1 1/2	382 x 611 x 38	R_NNN-T01524	325	394
	Specify the finish (5, 6). Smooth edge (N).				



PEDESTALS

Fixed pedestals - integrated pulls	<i>Fixed pedestals may be affixed underneath a work surface (drilling required).</i>				
	<i>2 box drawers, 1 file drawer.</i>				
	14 ³ / ₄ x 28 x 27 ⁷ / ₈	375 x 711 x 708	RID__-P1528UF		837
	14 ³ / ₄ x 22 x 27 ⁷ / ₈	375 x 559 x 708	RID__-P1522UF		807
	14 ³ / ₄ x 18 x 27 ⁷ / ₈	375 x 457 x 708	RID__-P1518UF		819
	Specify the pull code (F, R). Specify the accent color (A, S).				
	<i>2 file drawers.</i>				
	14 ³ / ₄ x 28 x 27 ⁷ / ₈	375 x 711 x 708	RID__-P1528FF		778
	14 ³ / ₄ x 22 x 27 ⁷ / ₈	375 x 559 x 708	RID__-P1522FF		748
	14 ³ / ₄ x 18 x 27 ⁷ / ₈	375 x 457 x 708	RID__-P1518FF		764
	Specify the pull code (F, R). Specify the accent color (A, S).				

Fixed pedestals - external pulls	<i>Fixed pedestals may be affixed underneath a work surface (drilling required).</i>				
	<i>2 box drawers, 1 file drawer.</i>				
	14 ³ / ₄ x 28 x 27 ⁷ / ₈	375 x 711 x 708	RID__-P1528UF		837
	14 ³ / ₄ x 22 x 27 ⁷ / ₈	375 x 559 x 708	RID__-P1522UF		807
	14 ³ / ₄ x 18 x 27 ⁷ / ₈	375 x 457 x 708	RID__-P1518UF		819
	Specify the pull code (K, M, Z, W). Specify the accent color (A, S).				
	<i>2 file drawers.</i>				
	14 ³ / ₄ x 28 x 27 ⁷ / ₈	375 x 711 x 708	RID__-P1528FF		778
	14 ³ / ₄ x 22 x 27 ⁷ / ₈	375 x 559 x 708	RID__-P1522FF		748
	14 ³ / ₄ x 18 x 27 ⁷ / ₈	375 x 457 x 708	RID__-P1518FF		764
	Specify the pull code (K, M, Z, W). Specify the accent color (A, S).				

METAL STORAGE FURNITURE

	W x D x H (in)	W x D x H (mm)	Code	Price (\$)
Mobile pedestals - integrated pulls	<i>Black casters.</i>			
	<i>2 box drawers, 1 file drawer.</i>			
	14 ³ / ₄ x 28 x 26 ¹ / ₂	375 x 711 x 673	RID__-MP1528UF	912
	14 ³ / ₄ x 22 x 26 ¹ / ₂	375 x 559 x 673	RID__-MP1522UF	881
14 ³ / ₄ x 18 x 26 ¹ / ₂	375 x 457 x 673	RID__-MP1518UF	898	
	Specify the pull code (F, R). Specify the accent color (A, S).			
	<i>2 file drawers.</i>			
	14 ³ / ₄ x 28 x 26 ¹ / ₂	375 x 711 x 673	RID__-MP1528FF	854
	14 ³ / ₄ x 22 x 26 ¹ / ₂	375 x 559 x 673	RID__-MP1522FF	825
	14 ³ / ₄ x 18 x 26 ¹ / ₂	375 x 457 x 673	RID__-MP1518FF	842
	Specify the pull code (F, R). Specify the accent color (A, S).			
	<i>1 box drawer, 1 file drawer. Can accommodate a RINNN-CU15_____ cushion.</i>			
	14 ³ / ₄ x 28 x 20 ⁷ / ₈	375 x 711 x 530	RID__-MP1528F	793
	14 ³ / ₄ x 22 x 20 ⁷ / ₈	375 x 559 x 530	RID__-MP1522F	765
	14 ³ / ₄ x 18 x 20 ⁷ / ₈	375 x 457 x 530	RID__-MP1518F	781
	Specify the pull code (F, R). Specify the accent color (A, S).			



Mobile pedestals - external pulls	<i>Black casters.</i>			
	<i>2 box drawers, 1 file drawer.</i>			
	14 ³ / ₄ x 28 x 26 ¹ / ₂	375 x 711 x 673	RID__-MP1528UF	912
	14 ³ / ₄ x 22 x 26 ¹ / ₂	375 x 559 x 673	RID__-MP1522UF	881
14 ³ / ₄ x 18 x 26 ¹ / ₂	375 x 457 x 673	RID__-MP1518UF	898	
	Specify the pull code (K, M, Z, W). Specify the accent color (A, S).			
	<i>2 file drawers.</i>			
	14 ³ / ₄ x 28 x 26 ¹ / ₂	375 x 711 x 673	RID__-MP1528FF	854
	14 ³ / ₄ x 22 x 26 ¹ / ₂	375 x 559 x 673	RID__-MP1522FF	825
	14 ³ / ₄ x 18 x 26 ¹ / ₂	375 x 457 x 673	RID__-MP1518FF	842
	Specify the pull code (K, M, Z, W). Specify the accent color (A, S).			
	<i>1 box drawer, 1 file drawer. Can accommodate a RINNN-CU15_____ cushion.</i>			
	14 ³ / ₄ x 28 x 20 ⁷ / ₈	375 x 711 x 530	RID__-MP1528F	793
	14 ³ / ₄ x 22 x 20 ⁷ / ₈	375 x 559 x 530	RID__-MP1522F	765
	14 ³ / ₄ x 18 x 20 ⁷ / ₈	375 x 457 x 530	RID__-MP1518F	781
	Specify the pull code (K, M, Z, W). Specify the accent color (A, S).			

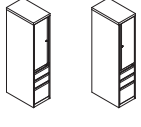

COMBINED TOWERS

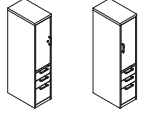

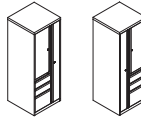
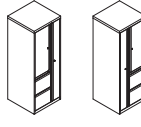



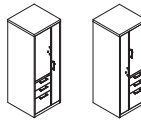
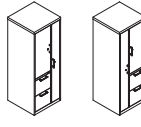



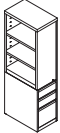
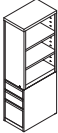

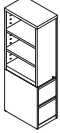
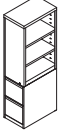
65¹/₂" H (1664 mm): closed cabinet or bookcase 35" H (889 mm) with 2 adjustable shelves.
53³/₈" H (1356 mm): closed cabinet or bookcase 23" H (584 mm) with 1 adjustable shelf.











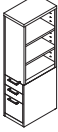

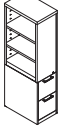
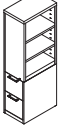
Combined towers with cabinet - integrated pulls	<i>1 cabinet, 2 box drawers, 1 file drawer.</i>			
	14 ³ / ₄ x 24 x 65 ¹ / ₂	375 x 610 x 1664	RID__-152466UFB_	1,822
	14 ³ / ₄ x 24 x 53 ³ / ₈	375 x 610 x 1356	RID__-152454UFB_	1,761
	Specify the pull code (F, R). Specify the accent color (A, S). Specify the door opening at the end of the code: hinges on left (L) ou hinges on right (R).			
	<i>1 cabinet, 2 file drawers.</i>			
	14 ³ / ₄ x 24 x 65 ¹ / ₂	375 x 610 x 1664	RID__-152466FFB_	1,798
	14 ³ / ₄ x 24 x 53 ³ / ₈	375 x 610 x 1356	RID__-152454FFB_	1,741
	Specify the pull code (F, R). Specify the accent color (A, S). Specify the door opening at the end of the code: hinges on left (L) ou hinges on right (R).			















Combined towers with cabinet - external pulls	<i>1 cabinet, 2 box drawers, 1 file drawer.</i>			
	14 ³ / ₄ x 24 x 65 ¹ / ₂	375 x 610 x 1664	RID__-152466UFB_	1,822
	14 ³ / ₄ x 24 x 53 ³ / ₈	375 x 610 x 1356	RID__-152454UFB_	1,761
	Specify the pull code (K, M, Z, W). Specify the accent color (A, S). Specify the door opening at the end of the code: hinges on left (L) ou hinges on right (R).			
	<i>1 cabinet, 2 file drawers.</i>			
	14 ³ / ₄ x 24 x 65 ¹ / ₂	375 x 610 x 1664	RID__-152466FFB_	1,798
	14 ³ / ₄ x 24 x 53 ³ / ₈	375 x 610 x 1356	RID__-152454FFB_	1,741
	Specify the pull code (K, M, Z, W). Specify the accent color (A, S). Specify the door opening at the end of the code: hinges on left (L) ou hinges on right (R).			











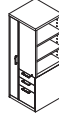

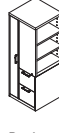

Combined towers with cabinet / wardrobe - integrated pulls	<i>1 cabinet on left, 2 box drawers, 1 file drawer, 1 wardrobe with clothes hanger bar on right.</i>			
	23 ³ / ₄ x 24 x 65 ¹ / ₂	603 x 610 x 1664	RID__-242466BUF	2,254
	23 ³ / ₄ x 24 x 53 ³ / ₈	603 x 610 x 1356	RID__-242454BUF	2,193
	Specify the pull code (F, R). Specify the accent color (A, S).			
	<i>1 cabinet on right, 2 box drawers, 1 file drawer, 1 wardrobe with clothes hanger bar on left.</i>			
	23 ³ / ₄ x 24 x 65 ¹ / ₂	603 x 610 x 1664	RID__-242466UFB	2,254
	23 ³ / ₄ x 24 x 53 ³ / ₈	603 x 610 x 1356	RID__-242454UFB	2,193
	Specify the pull code (F, R). Specify the accent color (A, S).			
	<i>1 cabinet on left, 2 file drawers, 1 wardrobe with clothes hanger bar on right.</i>			
	23 ³ / ₄ x 24 x 65 ¹ / ₂	603 x 610 x 1664	RID__-242466BFF	2,223
	23 ³ / ₄ x 24 x 53 ³ / ₈	603 x 610 x 1356	RID__-242454BFF	2,163
	Specify the pull code (F, R). Specify the accent color (A, S).			
	<i>1 cabinet on right, 2 file drawers, 1 wardrobe with clothes hanger bar on left.</i>			
	23 ³ / ₄ x 24 x 65 ¹ / ₂	603 x 610 x 1664	RID__-242466FFB	2,223
	23 ³ / ₄ x 24 x 53 ³ / ₈	603 x 610 x 1356	RID__-242454FFB	2,163
	Specify the pull code (F, R). Specify the accent color (A, S).			

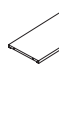
Combined towers with cabinet / wardrobe - external pulls	<i>1 cabinet on left, 2 box drawers, 1 file drawer, 1 wardrobe with clothes hanger bar on right.</i>			
	23 ³ / ₄ x 24 x 65 ¹ / ₂	603 x 610 x 1664	RID__-242466BUF	2,254
	23 ³ / ₄ x 24 x 53 ³ / ₈	603 x 610 x 1356	RID__-242454BUF	2,193
	Specify the pull code (K, M, Z, W). Specify the accent color (A, S).			
	<i>1 cabinet on right, 2 box drawers, 1 file drawer, 1 wardrobe with clothes hanger bar on left.</i>			
	23 ³ / ₄ x 24 x 65 ¹ / ₂	603 x 610 x 1664	RID__-242466UFB	2,254
	23 ³ / ₄ x 24 x 53 ³ / ₈	603 x 610 x 1356	RID__-242454UFB	2,193
	Specify the pull code (K, M, Z, W). Specify the accent color (A, S).			
	<i>1 cabinet on left, 2 file drawers, 1 wardrobe with clothes hanger bar on right.</i>			
	23 ³ / ₄ x 24 x 65 ¹ / ₂	603 x 610 x 1664	RID__-242466BFF	2,223
	23 ³ / ₄ x 24 x 53 ³ / ₈	603 x 610 x 1356	RID__-242454BFF	2,163
	Specify the pull code (K, M, Z, W). Specify the accent color (A, S).			
	<i>1 cabinet on right, 2 file drawers, 1 wardrobe with clothes hanger bar on left.</i>			
	23 ³ / ₄ x 24 x 65 ¹ / ₂	603 x 610 x 1664	RID__-242466FFB	2,223
	23 ³ / ₄ x 24 x 53 ³ / ₈	603 x 610 x 1356	RID__-242454FFB	2,163
	Specify the pull code (K, M, Z, W). Specify the accent color (A, S).			





		W x D x H (in)	W x D x H (mm)	Code	Price (\$)
Combined towers with bookcase					
<i>1 bookcase on left, 2 box drawers, 1 file drawer.</i>					
		14 3/4 x 24 x 65 1/2	375 x 610 x 1664	RID__-PUF152466	1,774
		14 3/4 x 24 x 53 3/8	375 x 610 x 1356	RID__-PUF152454	1,717
Specify the pull code (F, R). Specify the accent color (A, S).					
<i>1 bookcase on right, 2 box drawers, 1 file drawer.</i>					
		14 3/4 x 24 x 65 1/2	375 x 610 x 1664	RID__-P152466UF	1,774
		14 3/4 x 24 x 53 3/8	375 x 610 x 1356	RID__-P152454UF	1,717
Specify the pull code (F, R). Specify the accent color (A, S).					
<i>1 bookcase on left, 2 file drawers.</i>					
		14 3/4 x 24 x 65 1/2	375 x 610 x 1664	RID__-PFF152466	1,751
		14 3/4 x 24 x 53 3/8	375 x 610 x 1356	RID__-PFF152454	1,695
Specify the pull code (F, R). Specify the accent color (A, S).					
<i>1 bookcase on right, 2 file drawers.</i>					
		14 3/4 x 24 x 65 1/2	375 x 610 x 1664	RID__-P152466FF	1,751
		14 3/4 x 24 x 53 3/8	375 x 610 x 1356	RID__-P152454FF	1,695
Specify the pull code (F, R). Specify the accent color (A, S).					
Electronic lock option (D): add \$624.					

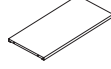
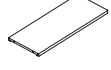

Combined towers with bookcase - external pulls					
<i>1 bookcase on left, 2 box drawers, 1 file drawer.</i>					
		14 3/4 x 24 x 65 1/2	375 x 610 x 1664	RID__-PUF152466	1,774
		14 3/4 x 24 x 53 3/8	375 x 610 x 1356	RID__-PUF152454	1,717
Specify the pull code (K, M, Z, W). Specify the accent color (A, S).					
<i>1 bookcase on right, 2 box drawers, 1 file drawer.</i>					
		14 3/4 x 24 x 65 1/2	375 x 610 x 1664	RID__-P152466UF	1,774
		14 3/4 x 24 x 53 3/8	375 x 610 x 1356	RID__-P152454UF	1,717
Specify the pull code (K, M, Z, W). Specify the accent color (A, S).					
<i>1 bookcase on left, 2 file drawers.</i>					
		14 3/4 x 24 x 65 1/2	375 x 610 x 1664	RID__-PFF152466	1,751
		14 3/4 x 24 x 53 3/8	375 x 610 x 1356	RID__-PFF152454	1,695
Specify the pull code (K, M, Z, W). Specify the accent color (A, S).					
<i>1 bookcase on right, 2 file drawers.</i>					
		14 3/4 x 24 x 65 1/2	375 x 610 x 1664	RID__-P152466FF	1,751
		14 3/4 x 24 x 53 3/8	375 x 610 x 1356	RID__-P152454FF	1,695
Specify the pull code (K, M, Z, W). Specify the accent color (A, S).					
Electronic lock option (D): add \$624.					

Combined towers with bookcase / wardrobe - integrated pulls					
<i>1 bookcase on left, 2 box drawers, 1 file drawer, 1 wardrobe with clothes hanger bar on right.</i>					
		23 3/4 x 24 x 65 1/2	603 x 610 x 1664	RID__-PBUF242466	2,226
		23 3/4 x 24 x 53 3/8	603 x 610 x 1356	RID__-PBUF242454	2,123
Specify the pull code (F, R). Specify the accent color (A, S).					
<i>1 bookcase on right, 2 box drawers, 1 file drawer, 1 wardrobe with clothes hanger bar on left.</i>					
		23 3/4 x 24 x 65 1/2	603 x 610 x 1664	RID__-P242466BUF	2,226
		23 3/4 x 24 x 53 3/8	603 x 610 x 1356	RID__-P242454BUF	2,123
Specify the pull code (F, R). Specify the accent color (A, S).					
<i>1 bookcase on left, 2 file drawers, 1 wardrobe with clothes hanger bar on right.</i>					
		23 3/4 x 24 x 65 1/2	603 x 610 x 1664	RID__-PBFF242466	2,153
		23 3/4 x 24 x 53 3/8	603 x 610 x 1356	RID__-PBFF242454	2,095
Specify the pull code (F, R). Specify the accent color (A, S).					
<i>1 bookcase on right, 2 file drawers, 1 wardrobe with clothes hanger bar on left.</i>					
		23 3/4 x 24 x 65 1/2	603 x 610 x 1664	RID__-P242466BFF	2,153
		23 3/4 x 24 x 53 3/8	603 x 610 x 1356	RID__-P242454BFF	2,095
Specify the pull code (F, R). Specify the accent color (A, S).					

		W x D x H (in)	W x D x H (mm)	Code	Price (\$)
Combined towers with bookcase / wardrobe - external pulls					
<i>1 bookcase on left, 2 box drawers, 1 file drawer, 1 wardrobe with clothes hanger bar on right.</i>					
		23 3/4 x 24 x 65 1/2	603 x 610 x 1664	RID__-PBUF242466	2,181
		23 3/4 x 24 x 53 3/8	603 x 610 x 1356	RID__-PBUF242454	2,123
Specify the pull code (K, M, Z, W). Specify the accent color (A, S).					
<i>1 bookcase on right, 2 box drawers, 1 file drawer, 1 wardrobe with clothes hanger bar on left.</i>					
		23 3/4 x 24 x 65 1/2	603 x 610 x 1664	RID__-P242466BUF	2,181
		23 3/4 x 24 x 53 3/8	603 x 610 x 1356	RID__-P242454BUF	2,123
Specify the pull code (K, M, Z, W). Specify the accent color (A, S).					
<i>1 bookcase on left, 2 file drawers, 1 wardrobe with clothes hanger bar on right.</i>					
		23 3/4 x 24 x 65 1/2	603 x 610 x 1664	RID__-PBFF242466	2,153
		23 3/4 x 24 x 53 3/8	603 x 610 x 1356	RID__-PBFF242454	2,095
Specify the pull code (K, M, Z, W). Specify the accent color (A, S).					
<i>1 bookcase on right, 2 file drawers, 1 wardrobe with clothes hanger bar on left.</i>					
		23 3/4 x 24 x 65 1/2	603 x 610 x 1664	RID__-P242466BFF	2,153
		23 3/4 x 24 x 53 3/8	603 x 610 x 1356	RID__-P242454BFF	2,095
Specify the pull code (K, M, Z, W). Specify the accent color (A, S).					

ACCESSORIES

Additional shelves					
<i>Insert into the storage units lateral notches. No tool required.</i>					
<i>For bookcases.</i>					
	41 3/4 x 16 3/4 x 3/4	1060 x 425 x 19	RINNN-TB4218		155
	35 3/4 x 16 3/4 x 3/4	908 x 425 x 19	RINNN-TB3618		149
	29 3/4 x 16 3/4 x 3/4	756 x 425 x 19	RINNN-TB3018		141
<i>For cabinets.</i>					
	41 3/4 x 14 1/4 x 3/4	1060 x 362 x 19	RINNN-TA4218		155
	35 3/4 x 14 1/4 x 3/4	908 x 362 x 19	RINNN-TA3618		149
	29 3/4 x 14 1/4 x 3/4	756 x 362 x 19	RINNN-TA3018		141
Pedestal and low storage unit cushions					
<i>Attaches to a mobile pedestal or on a low storage unit with velcro strip. Prices shown apply to all Grade 1 and 2 United Chair® fabrics. For other United Chair® grades, add: Grade 3: 15%, Grade 4: 20%, Grade 5: 25% and Grade 6: 30%.</i>					
<i>For mobile pedestals.</i>					
	14 3/4 x 28 x 1 1/2	375 x 711 x 40	RINNN-CU1528		349
	14 3/4 x 22 x 1 1/2	375 x 559 x 40	RINNN-CU1522		268
	14 3/4 x 18 x 1 1/2	375 x 457 x 40	RINNN-CU1518		222
<i>For low storage units.</i>					
	42 x 18 x 1 1/2	1067 x 457 x 40	RINNN-CU4218		400
	36 x 18 x 1 1/2	914 x 457 x 40	RINNN-CU3618		364
	30 x 18 x 1 1/2	762 x 457 x 40	RINNN-CU3018		296

Counterweights					
<i>Installation required. Includes counterweight and attachment brackets. Counterweight may be factory installed by adding 'W' at the end of the product code.</i>					
<i>For vertical files with 2 or 3 drawers (VF2 to VF3):</i>					
	17 3/4" W		RINNN-CW18		281
	14 3/4" W		RINNN-CW15		268
<i>For low storage units, multifunction files and combined lateral cabinets/files with 1 drawer (BE, SLF, CO and LFB):</i>					
	42" W		RINNN-C3W42		461
	36" W		RINNN-C3W36		423
	30" W		RINNN-C3W30		335

METAL STORAGE FURNITURE

	W x D x H (in)	W x D x H (mm)	Code	Price (\$)
Counterweights (cont'd)	<i>For lateral files and combined lateral cabinets/files with 2 or 3 drawers (LF2 to LF3, LF2B and LF3B):</i>			
	42" W		RINNN-C2W42	461
	36" W		RINNN-C2W36	386
	30" W		RINNN-C2W30	296
	<i>For lateral files with 4 drawers (LF4):</i>			
	42" W		RINNN-C1W42	296
	36" W		RINNN-C1W36	281
	30" W		RINNN-C1W30	268

Paradigm storage-to-panel attachment filler *Attaches to the back of a metal storage unit and to an Paradigm acoustical panel in order to replace a panel bracket. May be used with any surface with 2" (50 mm) more than the depth of the metal storage furniture. Installation and drilling required.*

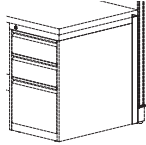

Shown: Installation on right (R)

2 x 2 x 27 ⁷ / ₈	50 x 50 x 708	RINNN-EGM2_	152
--	---------------	-------------	-----

Specify installation on left (L) or right (R)

Front-to-back hanging bars for lateral file drawers *2-bar kit. To create 2 letter or legal-size filing rows, 4 bars are needed, except for the 42" wide drawer, which needs 6 bars to create 3 letter-size filing rows. See page 4 for further information about filing capacity.*

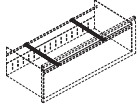

15 ¹ / ₈ x 1 ¹ / ₄ x 1 ¹ / ₄	384 x 32 x 32	LGC-FTB2	49
--	---------------	----------	----

Ganging kit *Allows to attach two storage units back-to-back (2 or more drawers) or side-by-side (3 or more drawers). The mounting kit is an efficient alternative to the use of counterweights. Hole drilling required.*



RINNN-GKIT	59
------------	----

Divider for lateral file drawer or low storage unit box drawer *For lateral file or low storage unit utility drawer. Inserts into the drawer slots every 1" (25 mm).*

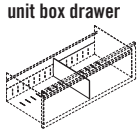

18 x ¹ / ₁₆ x 6	457 x 2 x 152	RINNN-DIV6	20
---------------------------------------	---------------	------------	----

	W x D x H (in)	W x D x H (mm)	Code	Price (\$)
Magnetic dividers for lateral or vertical file	<i>For vertical or lateral file.</i>			
	6 x 15 x 6	152 x 381 x 152	RINNN-DIV186	81
	6 x 12 x 6	152 x 305 x 152	RINNN-DIV156	81



For utility drawer.

2 x 15 x 2	51 x 381 x 51	RINNN-DIV182	68
2 x 12 x 2	51 x 305 x 51	RINNN-DIV152	68

Compressors

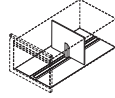

For vertical file. Comes with a grooved drawer bottom and a bracket with a clip.

Letter size.	RINNN-COM15	104
Legal size.	RINNN-COM18	104

Pencil tray for box drawer

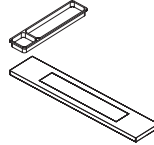

Black plastic. Sits on the sides of a 15" W (381 mm) utility drawer and slides from front to back for drawer access.

Pencil tray for multifunction unit 30" W.

12 ⁷ / ₈ x 3 x 1	327 x 76 x 25	RINNN-PHU	37
--	---------------	-----------	----

Metal tray adaptors (pencil tray sold separately).

For multifunction unit 36" W	RINNN-PHUA18	28
For multifunction unit 42" W	RINNN-PHUA21	33

Label holders



Insert into the integrated pulls. Clear plastic.

For full pull (F)	RINNN-PLHF	8
For recessed aluminum pull (R)	RINNN-PLHR	8

Electronic locks



Installation and hole drilling required. For further information, see electronic lock specifications, page 5.

For lateral or vertical file (horizontal position).

5 ¹ / ₄ x ¹ / ₂ x 1 ¹ / ₄	133 x 13 x 32	RINN_-DHLK	268
---	---------------	------------	-----

Specify the accent color (A, S).

For cabinet or wardrobe (vertical position).

1 ¹ / ₄ x ¹ / ₂ x 5 ¹ / ₄	32 x 13 x 133	RINN_-DVUK	268
---	---------------	------------	-----

Specify the accent color (A, S).

Manager Key	RINNN-DMK	127
Programming Key	RINNN-DPK	187

Important:

For conditions of sale, the full product offering or more information on all Lacasse collections, please consult Lacasse's General Price Book.

Office Furniture Solutions

Founded in 1956, Groupe Lacasse is a North American leader in the design, manufacture and service of a broad range of high-quality furniture products for all types of work environments. We have the experience, expertise and capability to deliver incomparable design, exceptional quality, optimum service and outstanding value in Office Furniture Solutions.



1-888-522-2773

www.grounelacasse.com